

8S3 Series Forged Steel Ball Valve Standard Port - Trunnion Mount

STANDARDS

DESIGN:

API 6D, API 608
API 607/API 6FA
ASME B16.34

TESTING:

API 598

PRESSURE CLASS:

FLANGED - 300

CONNECTIONS:

FLANGED - ASME B16.5
ASME B16.10

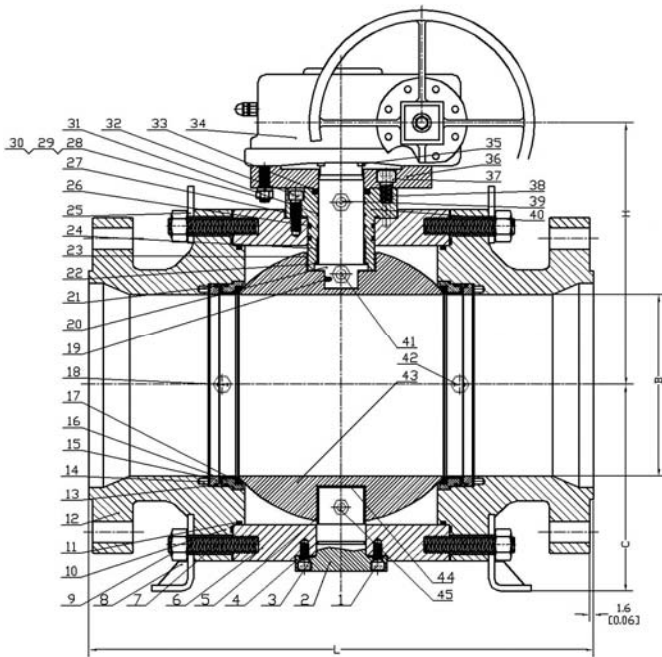

DIMENSIONS						
SIZE		L	B	C	H	Weight Lbs/Kg
2	Inch	8.50	1.50	2.75	4.75	65.0
	mm	216.0	38.0	70.0	120.5	29.5
3	Inch	11.12	1.97	3.26	5.35	83.8
	mm	282.0	50.0	83.0	136.0	38.0
4	Inch	12.00	3.00	4.33	6.85	132.3
	mm	305.0	76.0	110.0	174.0	60.0
6	Inch	15.88	3.94	5.31	8.06	246.9
	mm	403.0	100.0	135.0	205.0	112.0
8	Inch	19.75	5.91	7.00	10.81	533.5
	mm	502.0	150.0	178.0	275.0	242.0
10	Inch	22.38	7.88	10.25	12.43	817.9
	mm	568.0	200.0	260.0	315.0	371.0
12	Inch	25.50	9.92	12.60	14.96	1311.7
	mm	635.0	252.0	320.0	380.0	595.0
16	Inch	33.00	11.93	13.38	16.53	1849.6
	mm	838.0	303.0	340.0	420.0	839.0

MATERIAL SPECIFICATIONS				
NO.	Part Name	Carbon Steel/304	Stainless Steel/316	LF2/304
1	Screw	A193 Gr. B7	A193 Gr. B8	A193 Gr. B7
2	Bottom Stem	4140/ENP	A182 Gr. F316	A350 Gr. LF2
3	Gasket	304/Graphite	316/Graphite	304/Graphite
4	O-Ring	Viton	Viton	Viton
5	Bearing	316/PTFE	316/PTFE	316/PTFE
6	Body	A105N	A182 Gr. F316	A350 Gr. LF2
7	Body Stud	A193 Gr. B7	A193 Gr. B8	A193 Gr. L7M
8	Support Foot	ASTM A570	ASTM A570	ASTM A570
9	Nut	A194 Gr. 2H	A194 Gr. 8M	A194 Gr. 2H
10	Gasket	304/Graphite	316/Graphite	304/Graphite
11	O-Ring	Viton	Viton	Viton
12	End Piece	A105N	A182 Gr. F316	A350 Gr. LF2
13	Seal	Graphite	Graphite	Graphite
14	Spring	Inconel X-750	Inconel X-750	Inconel X-750
15	Pressure Plate	A182 Gr. F304	A182 Gr. F316	A182 Gr. F304
16	Seat Holder	A182 Gr. F304	A182 Gr. F316	A182 Gr. F304
17	Seat	PTFE	PTFE	PTFE
18	Grease Fitting	Carbon Steel/ZN	316SS	Carbon Steel/Zn
19	Anti-Static Device	SS316	SS316	SS316
20	Stem	17-4PH	17-4PH	17-4PH
21	O-Ring	Viton	Viton	Viton
22	Gasket	PTFE	PTFE	PTFE
23	Bearing	316/PTFE	316/PTFE	316/PTFE
24	Bearing	316/PTFE	316/PTFE	316/PTFE
25	Lifting Eye	Carbon Steel	316 SST	Carbon Steel
26	O-Ring	Viton	Viton	Viton
27	Gasket	304/Graphite	316/Graphite	304/Graphite
28	Bolt	A193 Gr. B7	A193 Gr. B8	A193 Gr. B7
29	Spring Washer	AISI 1066	AISI 316	ASI 1066
30	Nut	A194 Gr. 2H	A194 Gr. 8M	A194 Gr. 2H
31	O-Ring	Viton	Viton	Viton
32	Screw	A193 Gr. B7	A193 Gr. B8	A193 Gr. B7
33	Packing	Graphite	Graphite	Graphite
34	Gear			
35	Key	AISI 1045	AISI 1045	AISI 1045
36	Mounting Plate	AISI 1025	AISI 1025	AISI 1025
37	Screw	A193 Gr. B7	A193 Gr. B8	A193 Gr. B7
38	Straight Pin	304	316	316
39	Grease Fitting	Carbon Steel/ZN	316SS	Carbon Steel/Zn
40	Stem Box	A105N	A182 Gr. F316	A350 Gr. LF2
41	Relief Valve	Carbon Steel/ZN	316SS	Carbon Steel/Zn
42	Check Valve	Carbon Steel/ZN	316SS	Carbon Steel/Zn
43	Ball	A182 Gr. F304	A182 Gr. F316	A182 Gr. F304
44	Gasket	PTFE	PTFE	PTFE
45	Relief Valve	Carbon Steel/ZN	316SS	Carbon Steel/Zn

NOTE:

COMPONENTS MAY CHANGE ACCORDING TO VALVE SIZE.
CONTACT BERIC FOR CERTIFIED DRAWINGS.

ADDITIONAL VALVE BODY AND TRIM MATERIALS AVAILABLE.

(713) 673-2073 - Fax (713) 673-4641 - Toll Free (866) GO-BERIC (462-3742)

www.bericvalves.com

Rev. 010113

Copyright 2013

Page 17BV